

CSM 1000 / 2000 L

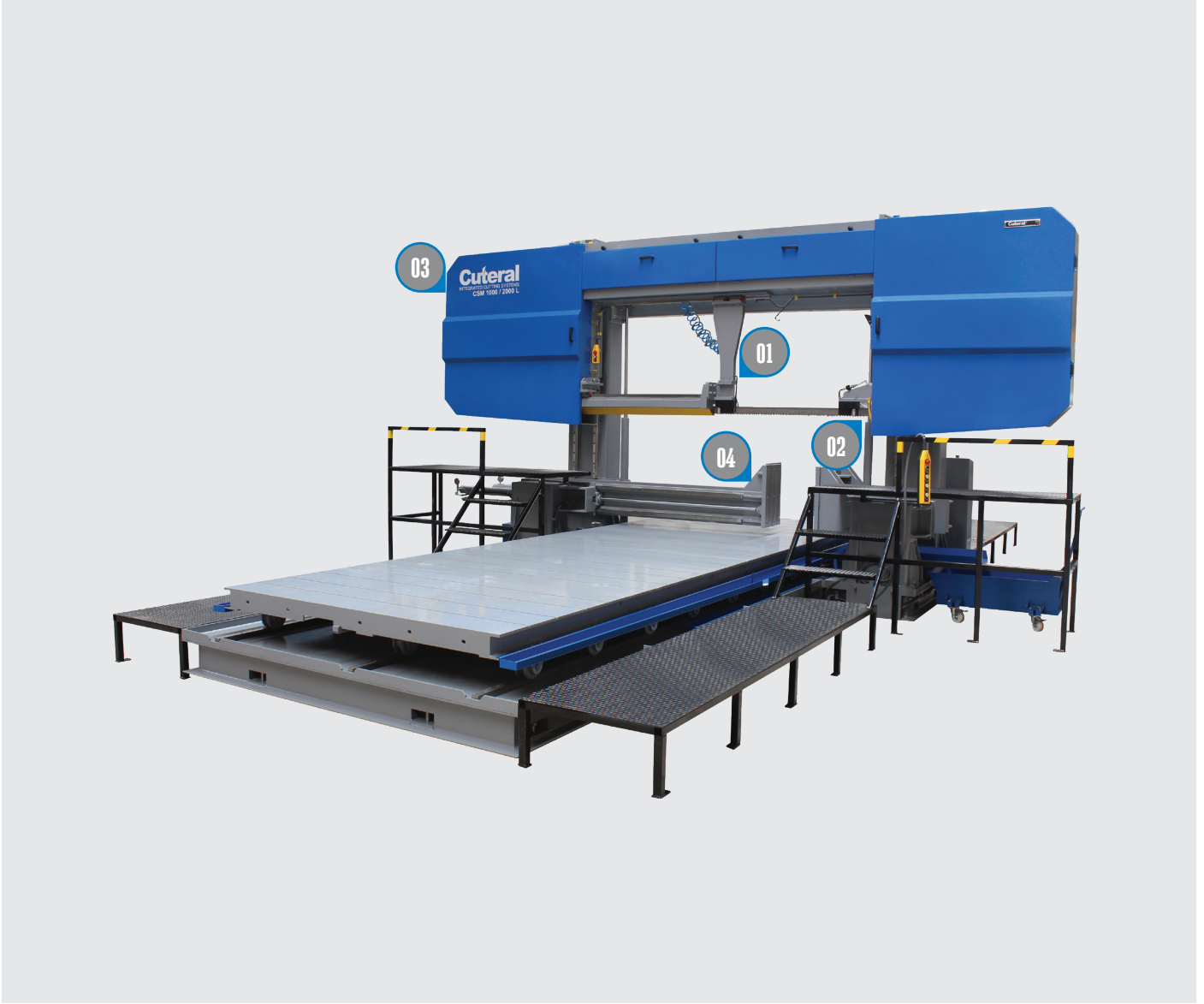

YARI OTOMATİK HİDROLİK SÜTUNLU TESTERE TEZGAHI SEMI AUTOMATIC DOUBLE COLUMN HYDRAULIC BANDSAW MACHINE



HAREKET SİSTEMİ
LINEAR GUIDING

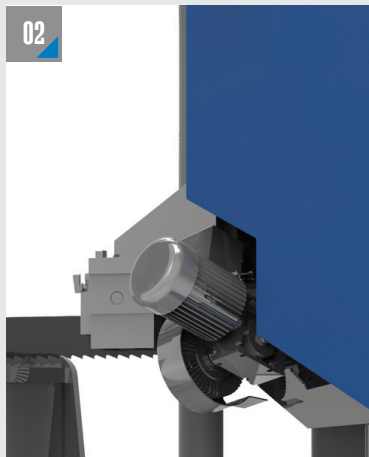

TALAŞ TEMİZLEME FIRÇASI
CHIP BRUSH

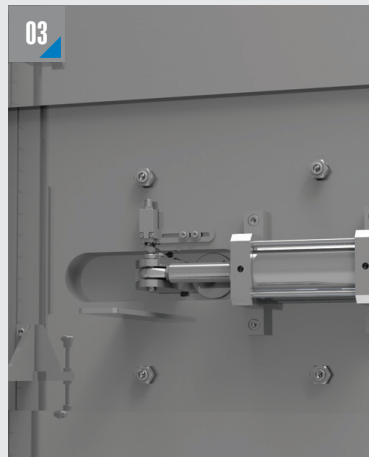

ŞERİT GERDİRME SİSTEMİ
BLADE TENSIONING



MENGENE SİSTEMİ
CLAMPING SYSTEM





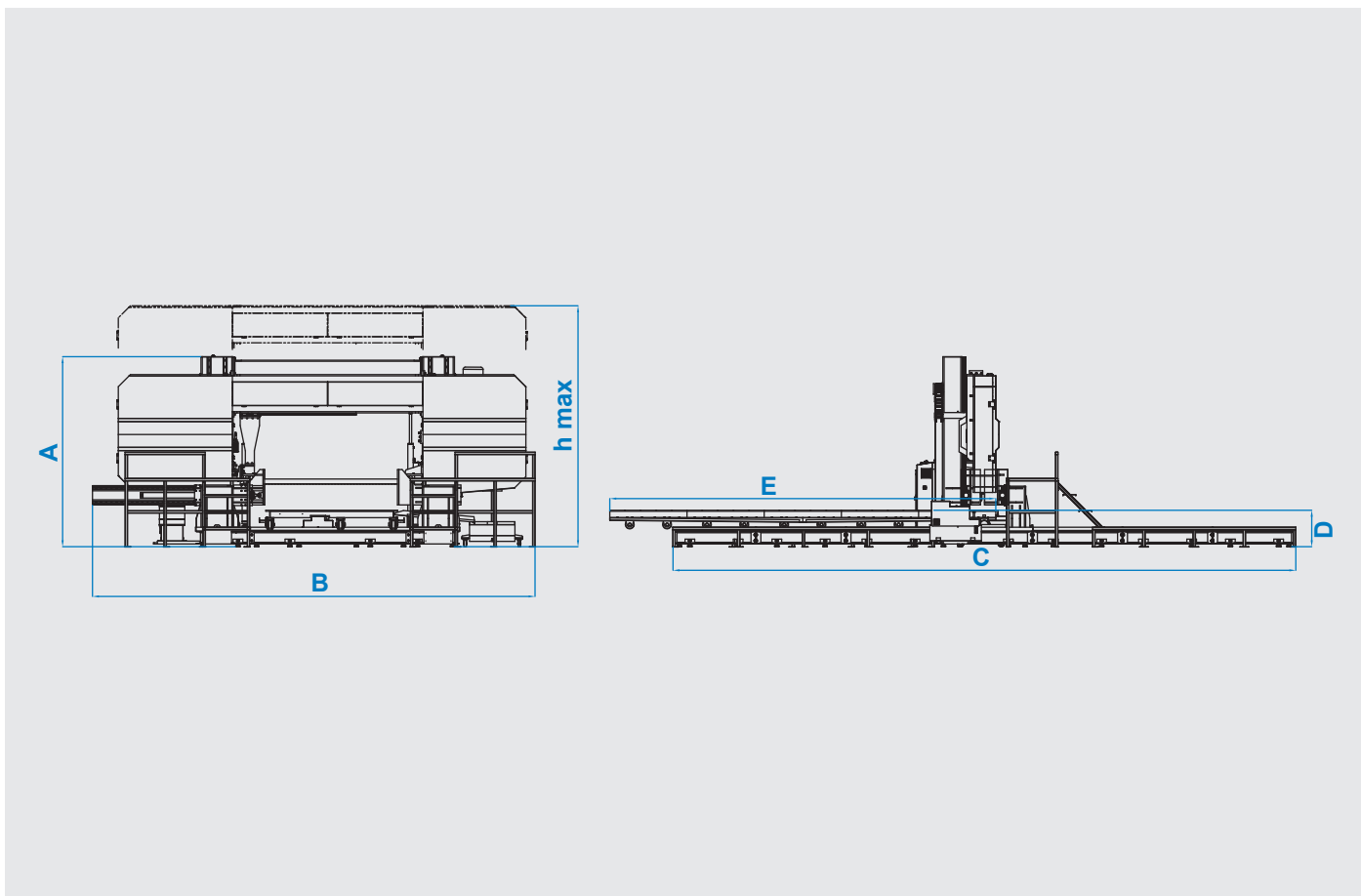





ÖLÇÜLER DIMENSIONS

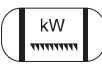

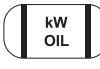
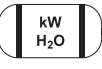

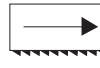





SÜTUNLU MODELLER DOUBLE COLUMN TYPES



TEKNİK ÖZELLİKLER / TECHNICAL FEATURES

A	2960 mm 116.54 inch	B	6880 mm 270.87 inch	C	96820 mm 3811.81 inch	D	600 mm 23.62 inch	E	6000 mm 236.22 inch	hmax	3540 mm 139.37 inch
---	------------------------	---	------------------------	---	--------------------------	---	----------------------	---	------------------------	------	------------------------

 Yarı Otomatik Semi Automatic	 Serit Ölçüsü Blade Dimension 80 x 1.6 x 14015 mm 3.15 x 0.063 x 551.77 inch	 Serit Motoru Blade Motor 11 kW - 1500 d/d 14.75 hp - 1500 rpm	 Talaş Konveyör Motoru Chip Conveyor Motor 0.09 kW - 1500 d/dk 0.12 hp - 1500 rpm
 Hidrolik Motor Hydraulic Pump Motor 3 kW - 1500 d/dk 4 hp - 1500 rpm	 Soğutucu Motor Cooling Liquid Motor 0.75 kW - 1500 d/dk 1 hp - 1500 rpm	 Voltaj Voltage 400 V 400 V	 Maksimum Güç Maximum Power 15.64 kW 20.97 hp
 Kesme Hızı Cutting Speed 15 m/dk - 49 m/dk 60 m/dk - 196 ft/min	 Ağırlık Weight 18000 kg 39683.20 lbs	 Malzeme Sıkma Sistemi Material Clamping System Hidrolik Hydraulic	 Serit Germe Sistemi Blade Tensioning System Hidrolik Hydraulic

 Kesim Kapasitesi Cutting Capacity 1000 mm 39.37 inch	 Kesim Kapasitesi Cutting Capacity 2000 mm 78.74 inch	 90°	 60°	 45°	 30°	 0°	 90°	 45°	 60°