

PSM 220 M PRATİK



MANUEL AÇILI TESTERE TEZGAHI MANUAL MITER BANDSAW MACHINE



MALZEME SIKMA SİSTEMİ
MATERIAL CLAMPING SYSTEM



AÇI SABİTLEME
FIXING MITER DEGREE



KUMANDA PANELİ
CONTROL PANEL



AÇILI KESİM
MITER CUTTING





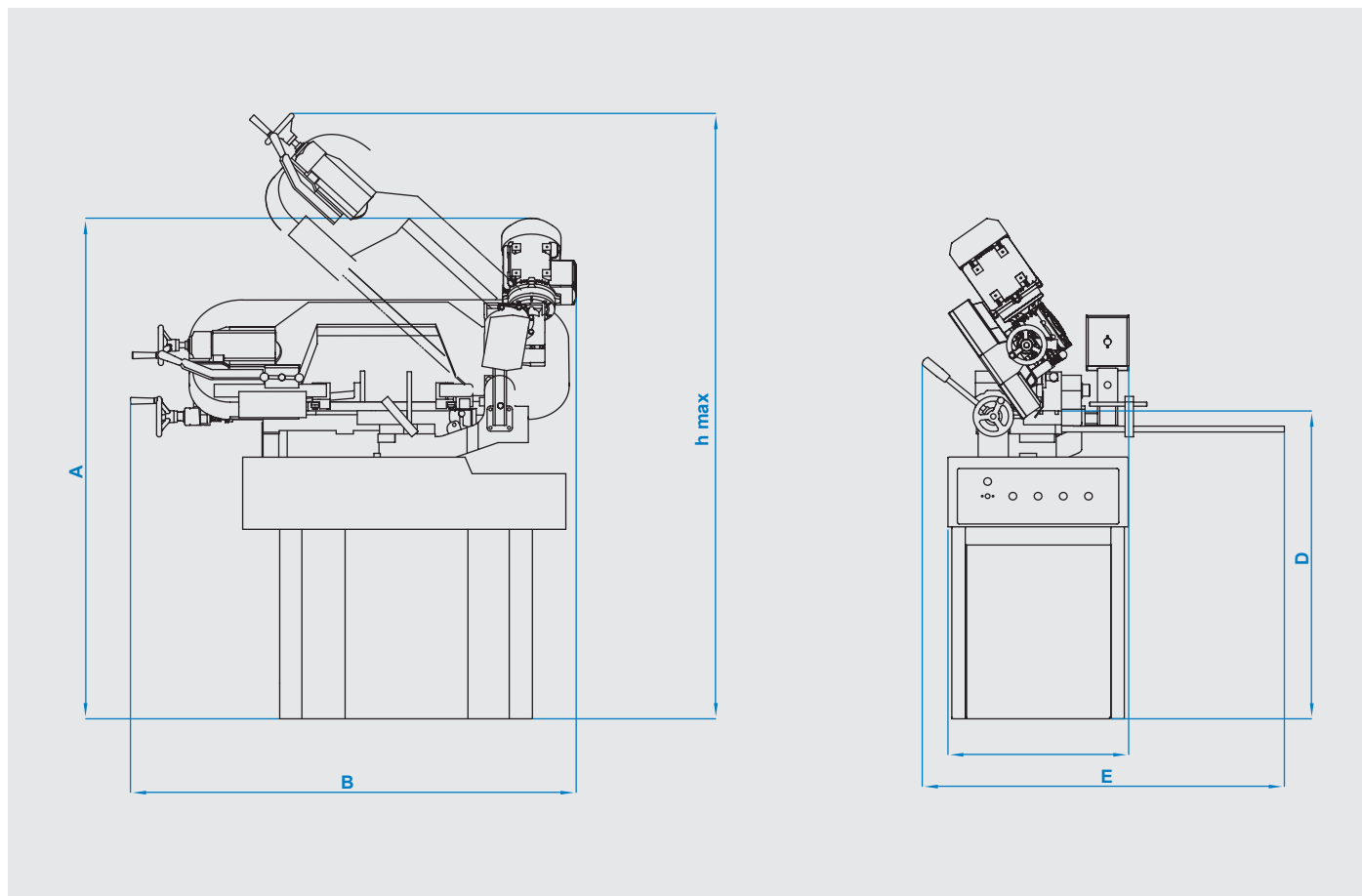

ÖLÇÜLER DIMENSIONS

MAFSALLI MODELLER PIVOT TYPES

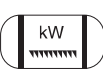
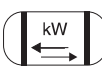
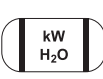

TEKNİK ÖZELLİKLER / TECHNICAL FEATURES

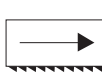
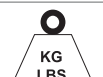
A	1485 mm 58.46 inch	B	1323 mm 55.35 inch	C	538 mm 21.18 inch	D	915 mm 36.02 inch	E	1075 mm 42.32 inch	hmax	1800 mm 70.87 inch
---	-----------------------	---	-----------------------	---	----------------------	---	----------------------	---	-----------------------	------	-----------------------

 Yarı Otomatik Semi Automatic	 Şerit Ölçüsü Blade Dimension 27 x 0.9 x 2500 mm 1 x 0.035 x 98.40 inch	 kW Şerit Motoru Blade Motor 1.1 kW - 1400 d/d 1.47 hp - 1400 rpm	 kW Sürücü Motor Feeding Motor Manuel Manual
 kW H ₂ O Soğutucu Motor Cooling Liquid Motor 0.12 kW - 3000 d/dk 0.16 hp - 3000 rpm	 Voltaj Voltage 220 V 220 V	 Maksimum Güç Maximum Power 1.22 kW 1.47 hp	 Kesme Hızı Cutting Speed 25 m/dk - 82 ft/min 90 m/dk - 295 ft/min
 KG LBS Ağırlık Weight 250 kg 551.16 lbs	 Malzeme Sıkma Sistemi Material Clamping System Manuel Manual	 Şerit Germe Sistemi Blade Tensioning System Hidromekanik Hydromechanic	

Kesim Kapasitesi Cutting Capacity		Kesim Kapasitesi Cutting Capacity		Kesim Kapasitesi Cutting Capacity		Kesim Kapasitesi Cutting Capacity		Kesim Kapasitesi Cutting Capacity	
220 mm 8.66 inch	250 mm 9.84 inch	220 mm 8.66 inch	250 mm 9.84 inch	200 mm 7.87 inch	180 mm 7.09 inch	150 mm 5.91 inch	140 mm 5.51 inch	80 mm 3.15 inch	80 mm 3.15 inch
